

REV	MODIFICATION	DATE	DRAW
A	NEW RELEASE PER ECDN07136	2007.11.12	Twiter
B	ECN08058 Δ X9 MIX9	2008.08.29	Sunshine

LEAD FREE

NOTES:
 1) MATERIAL:
 HOUSING: THERMOPLASTIC, UL 94V-0, 30%G/F FILLED;
 COLOR: BLACK
 CONTACT: BeCu COPPER ALLOY, T=0.15mm
 NAIL: STAINLESS STEEL, T=0.20mm
 2) FINISH:
 CONTACT: 15u" GOLD PLATING ON CONTACT AREA
 G/F PLATING ON SOLDER TAILS
 50u" MININICKEL UNDERPLATING OVER ALL
 NAIL: 50u" NICKEL UNDERPLATING,
 120u" TIN OVERALL

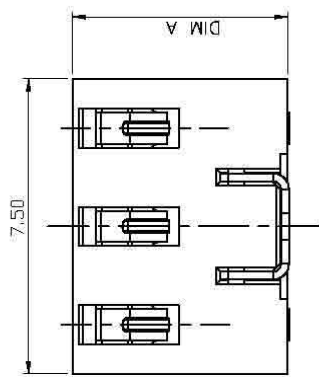
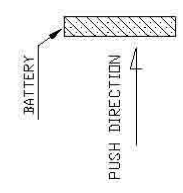
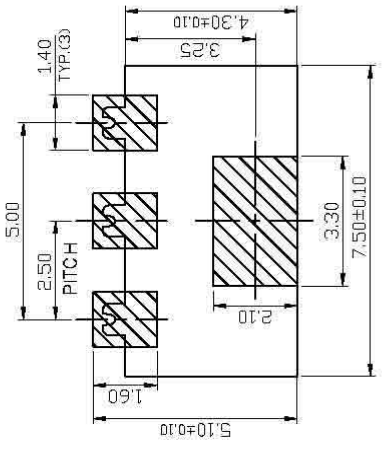
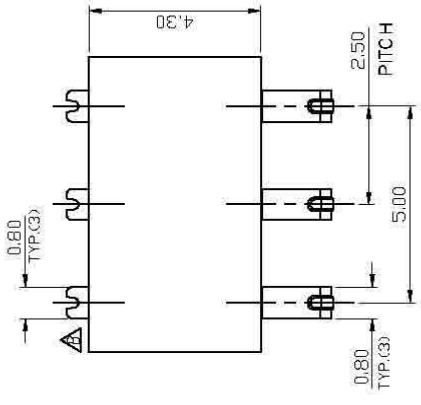

RECOMMENDED PCB LAYOUT
 TOP VIEW (XX±0.05)

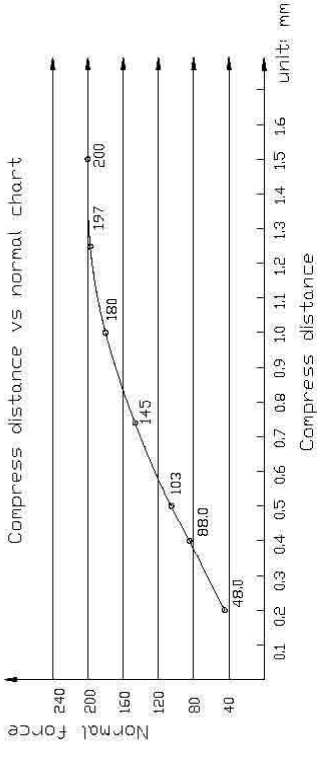
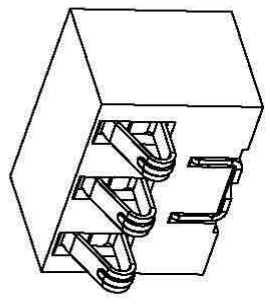

PRODUCT No.

PRODUCT No.	P/N	DIM A	DIM B	PACKAGE QTY
BAT00007500		7.50	5.5	700Pcs/Reel
BAT00007200		7.20	5.2	700Pcs/Reel
BAT00007000		7.00	5.0	700Pcs/Reel
BAT00006500		6.50	4.5	800Pcs/Reel
BAT00006200		6.20	4.2	800Pcs/Reel
BAT00006000		6.00	4.0	800Pcs/Reel
BAT00005800		5.80	3.8	800Pcs/Reel
BAT00005400		5.40	3.5	900Pcs/Reel

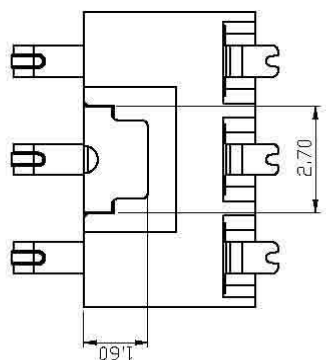

Wellco T&C Co., Ltd.	
TITLE: 3 PIN BATTERY CONNECTOR -VERTICAL (WITHOUT POST)	
DWG NO.	PART NO. SEE PRODUCT No.
PROJ.	CUSTOMER DRAWING
SIZE A4	SCALE 1:1
SHEET 1	REV. B

DIMENSION IN mm [Inch]	PROD. SPEC.
TOLERANCE UNLESS OTHERWISE SPECIFIED	PKG. SPEC.
.X±0.30	APR. James 2007.11.17
.XX±0.25	CHK. RuiXing 2007.11.17
.XXX±0.150	DRA. Twiter 2007.11.12