

REV.	Q'TY	ECN. NO.	APR.	DATE
A		NEW DWG		

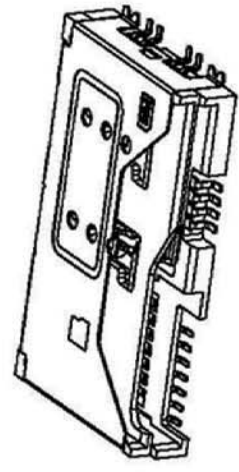

NOTES:

- 1) MATERIAL:
 - 1-1 HOUSING:THERMOPLASTIC,UL94 V-0,COLOR:BLACK
 - 1-2 CONTACT:COPPER ALLOY, T=0.15mm
 - 1-3 SHELL:STAINLESS STEEL T=0.15mm
 - 1-4 RIB:STAINLESS STEEL T=0.15mm
- 2) FINISH:
 - 2-1 CONTACT: Au PLATING ON CONTACT AREA (SEE P/N)
 - 2-2 SHELL:1u" MIN Au PLATING ON SOLDER AREA
 - 2-3 RIB:50u" MIN NICKEL UNDERPLATING OVER ALL
- 3) PRODUCT SPECIFICATIONS:
 - 3-1 VOLTAGE RATING: 50V
 - 3-2 CURRENT RATING: 0.5A
 - 3-3 INSULATION RESISTANCE: 1000MEG.OHM MIN
 - 3-4 CONTACT RESISTANCE: 100 MILL.OHM MAX
 - 3-5 OPERATION TEMPERATURE: -20° TO +85°
 - 3-6 DURABILITY: 3000 CYCLES

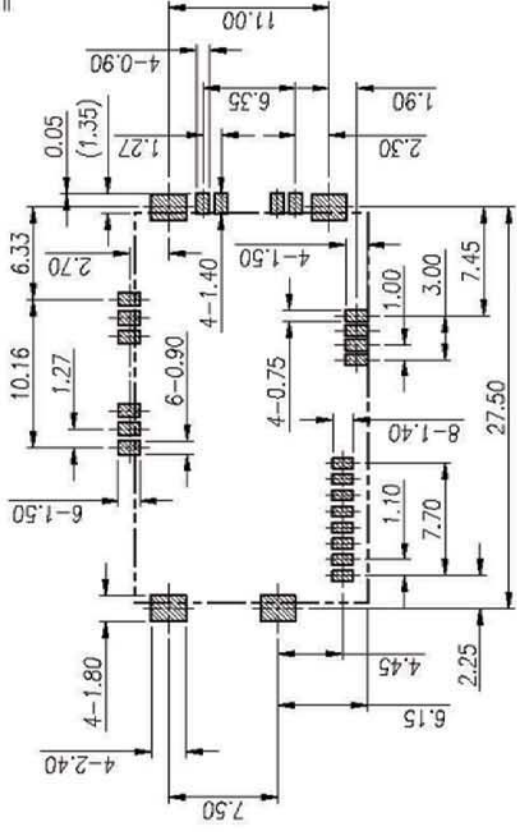
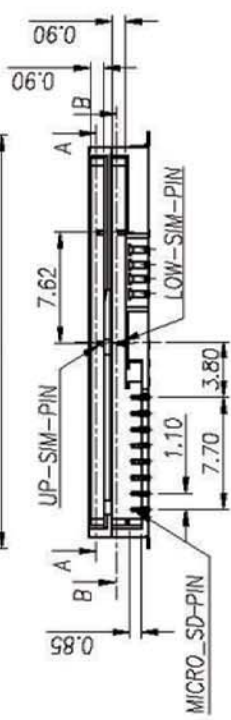
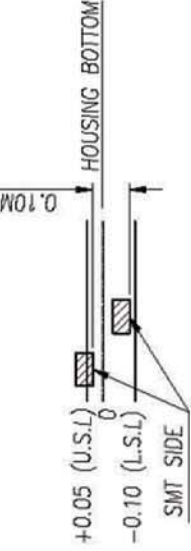
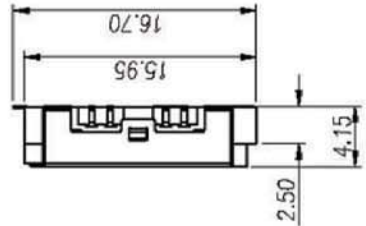
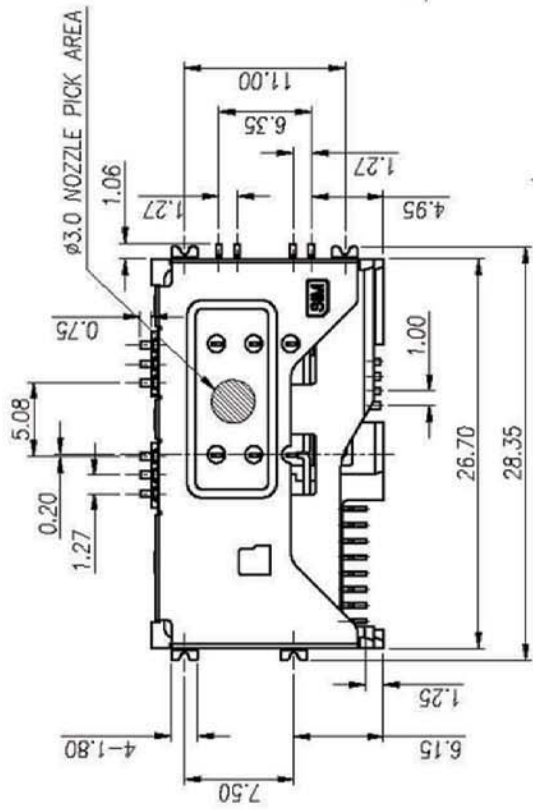

RECOMMENDED PCB LAYOUT
(TOLERANCE:±0.05)

WELICO T&C Co., Ltd.		TITLE: MICRO_SD+DOUBLE SIM CARD CONNECTOR	
All rights reserved,And should not be used without written permission		DWC NO. STIM000021C2R0-U	
APR.	DWG NO.	PROJ.	CUSTOMER DRAWING
CHK.		SIZE A4	SCALE 2:1
DRA.	YUXIAOBIN	SHEET 1/2	REV. A

REV.	QTY	ECN. NO.	APR.	DATE
A		NEW DWG		

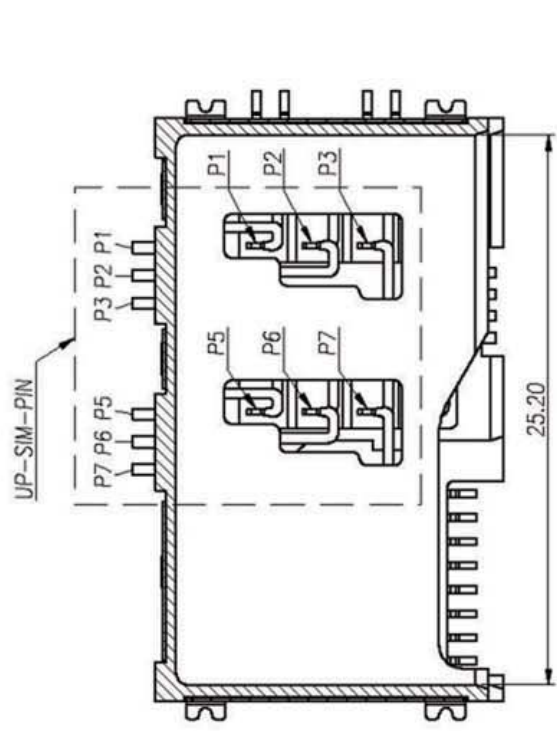

SECTION A-A

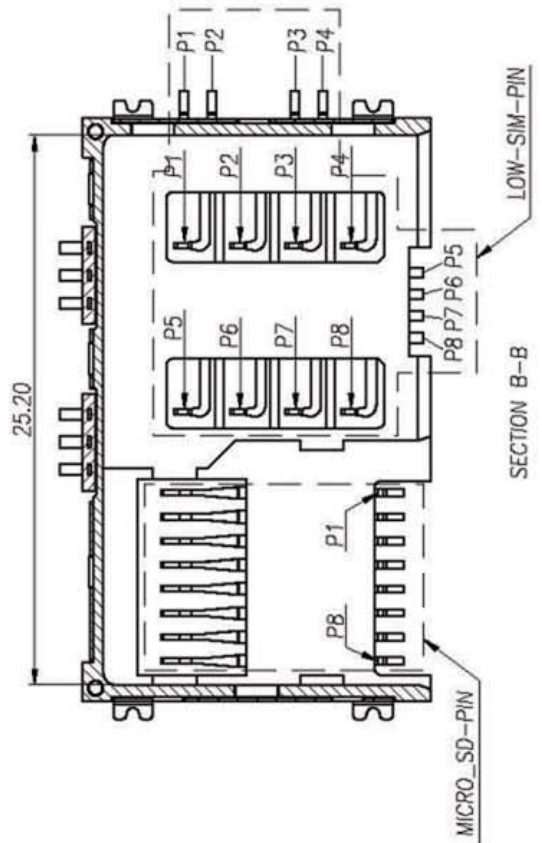

SECTION B-B

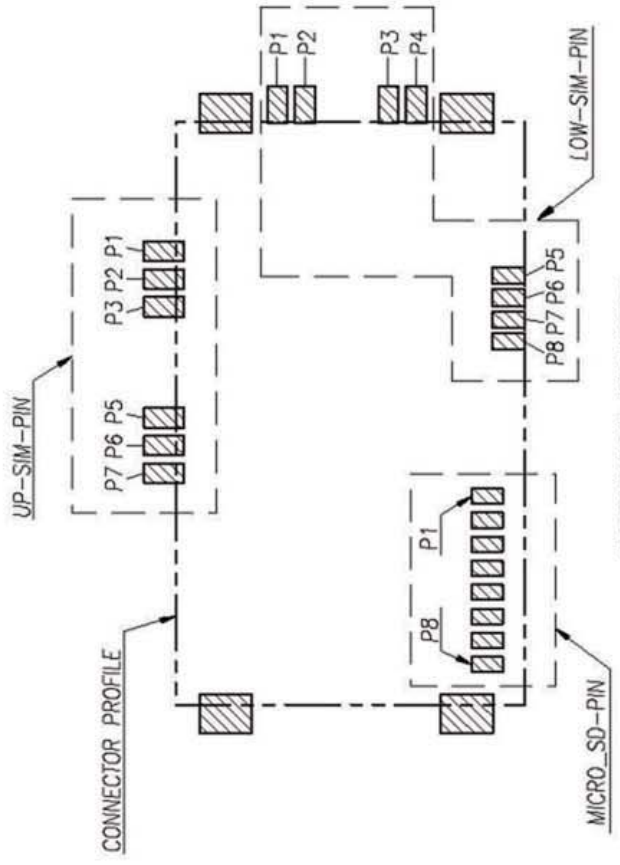

CONNECTOR PROFILE

RECOMMENDED PCB LAYOUT
(PIN ASSIGNMENT)

NAME	PIN 1	PIN 2	PIN 3	PIN 4	PIN 5	PIN 6	PIN 7	PIN 8
SIM-PIN	VCC	RST	CLK	RESERVED	GND	VPP	I/O	RESERVED
MICRO_SD-PIN	DAT 2	CD/DAT 3	CMD	VDD	CLK	VSS	DAT 0	DAT 1

DIMENSION IN mm		Wellco T&C Co., Ltd.	
TOLERANCE UNLESS OTHERWISE SPECIFIED		All rights reserved, And should not be used without written permission	
.X ± 0.35	X' ± 5'	APR.	TITLE: MICRO_SD+DOUBLE SIM CARD CONNECTOR
.XX ± 0.25	.X' ± 3'	CHK.	DWG NO. SIM000021C2R0-U
.XXX ± 0.15	.XX' ± 1'	DRA. YUXIAOBIN	PROJ. CUSTOMER DRAWING
		SIZE A4	SCALE 3:1
		SHEET 2	REV. A