

- Electrical Characteristics :**
- Insulation Resistance : 500MΩ Min.
 - Contact Resistance : 30mΩ Max.
 - Withstand Voltage : 500 VAC 1 minute.
 - Current Rating : 1.5A

Material:

Housing : Thermoplastic UL94V-0

Contact : Full Gold Plating

Spring Wire : Dia 0.45mm Phosphor Bronze

Optional Gold Plating Over Nickel

PART NO : 5 3 4 4 - B * 1

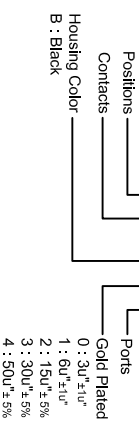

Wellco T&C Co., Ltd.

ZONE	REV.	DESCRIPTION	DATE	APPD.	FILE NO : 53 (SERIES)
(A)					TOLERANCE(公差) : 0.000 mm ± 0.075 mm 0.00 mm ± 0.15 mm 0.0 mm ± 0.25 mm
(B)					
(C)					
(D)					
(E)					

TITLE	4P4C TOP ENTRY PCB JACK	UNIT	mm
圖名		單位	inch
PART NO.	5344-B*1	SCALE	1:1
料號		比例	
REV.	A.0	DATE	2007-04-27
版本		日期	
CHECKED BY	Michael	DRAWN BY	Vallant
審核		製圖	

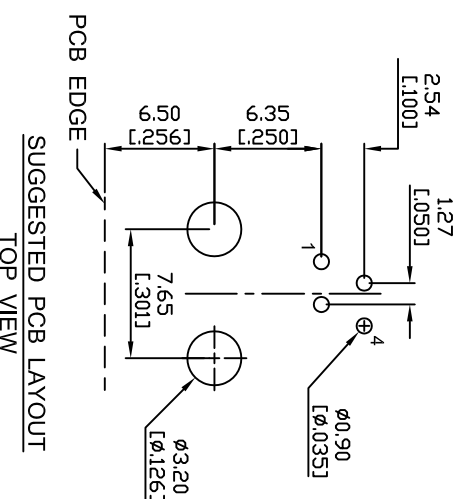
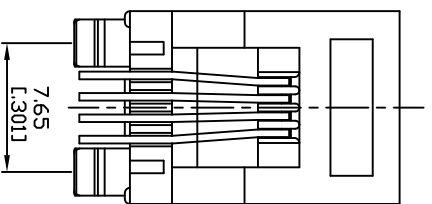
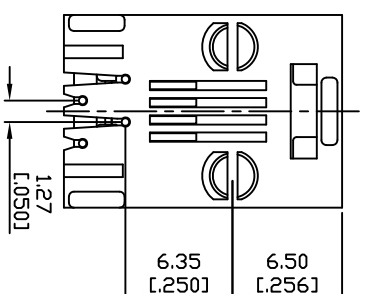
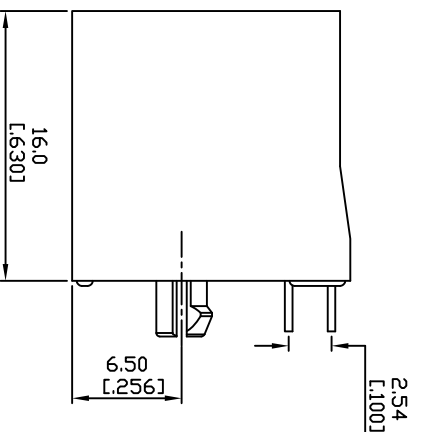
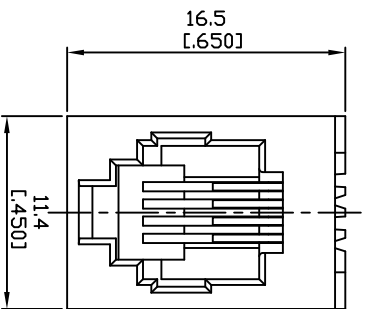

- Electrical Characteristics :**
- Insulation Resistance : 500M Ω Min.
 - Contact Resistance : 30m Ω Max.
 - Withstand Voltage : 500 VAC 1 minute.
 - Current Rating : 1.5A

Material:
 Housing : Thermoplastic UL94V-0
 Contact : Full Gold Plating
 Spring Wire : Dia 0.45mm Phosphor Bronze
 Optional Gold Plating Over Nickel

PART NO : 5 3 A 4 4 - B * 1

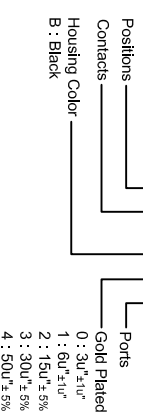

Wellco T&C Co., Ltd.

ZONE	REV.	DESCRIPTION	DATE	APPD.	FILE NO : 53 (SERIES)
(A)					TOLERANCE(公差) :
(B)					0.000 mm \pm 0.075 mm
(C)					0.00 mm \pm 0.15 mm
(D)					0.0 mm \pm 0.25 mm
(E)					

TITLE	4P4C TOP ENTRY PCB JACK	UNIT	mm
圖名		單位	mm
PART NO.	53A44-B*1	SCALE	1:1
料號		比例	
REV.	A.0	DATE	2007-04-19
版本		日期	
CHECKED BY	Michael	DRAWN BY	Vallant
審核		製圖	

